

Vitafoods
Europe 

The world's nutraceutical event

Join the Probiotics Pavilion at Vitafoods Europe 2023

9-11 May, Geneva, Switzerland / Online

VITAFOODS EVENTS 2023

PROBIOTIC RESOURCE CENTER

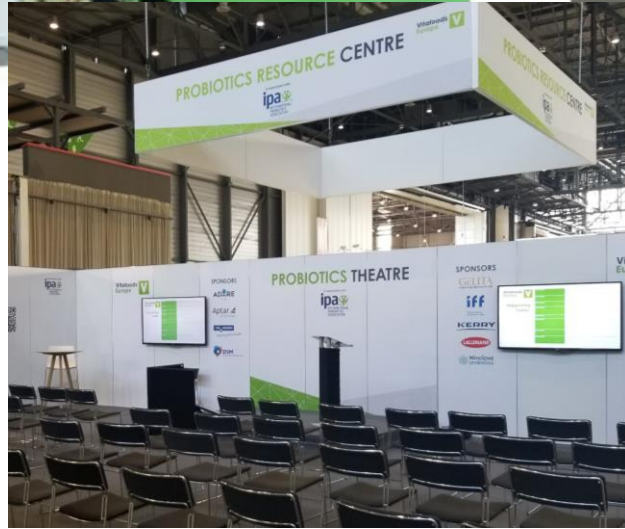

VITAFOODS EUROPE
GENEVA, SWITZERLAND
MAY 9-11, 2023

VITAFOODS EUROPE - FEATURE

- HYBRID EVENT :
 - 3 DAYS IN SWITZERLAND
 - 2 WEEKS ONLINE
- **+22,000 SENIOR INDUSTRY PROFESSIONALS** ATTENDING
 - INCLUDING **+1,250 GLOBAL SUPPLIERS**,
 - ALL FROM OVER **136 COUNTRIES**.
- THE PERFECT PLATFORM TO GENERATE NEW BUSINESS AND BUILD PROFITABLE RELATIONSHIPS ACROSS THE **EUROPEAN NUTRACEUTICAL AND FUNCTIONAL FOOD AND BEVERAGE MARKETS**.

VITAFOODS EUROPE - FEATURE

PARTICIPATING AT VITAFOODS EUROPE PUTS YOUR COMPANY AT THE HEART OF THE NUTRACEUTICAL INDUSTRY AND ALLOWS YOU TO ACCOMPLISH MULTIPLE BUSINESS OBJECTIVES DIGITALLY AND IN PERSON :

- **CONNECT DIGITALLY AND FACE TO FACE** WITH AN AUDIENCE LIKE NO OTHER – 96% OF EXHIBITORS MET VISITORS AT THE SHOW THAT THEY WOULDN'T HAVE MET ELSEWHERE. WE CAN OFFER YOU VIRTUAL MEETINGS TO ENGAGE THOSE POTENTIAL CLIENTS THAT DO NOT TRAVEL TO THE PHYSICAL EVENT IN GENEVA. WE ALSO HAVE ENHANCED MATCHMAKING OPPORTUNITY FOR BOTH IN PERSON AND DIGITAL MEETINGS.
- **GROW YOUR COMPANY PROFITS** – 93% OF EXHIBITORS BELIEVE VITAFOODS EUROPE DELIVERS MORE NEW LEADS THAN ANY OTHER SALES OR MARKETING ACTIVITY
- **FINALIZE DEALS** – 95% OF VISITORS HAVE DECISION-MAKING POWER

BACK TO VITAFOODS EUROPE 2022

- **THOUSANDS** OF PEOPLE
- **HUNDREDS** OF EXHIBITORS
 - LIVE SPEAKERS
 - NEW PRODUCTS
 - VIRTUAL TOURS
- NETWORKING OPPORTUNITIES
- ROUNDTABLE DISCUSSIONS
- PRODUCT TESTING
- WEBINARS
- RESEARCH INSIGHTS AND MORE. **2022** HAD IT ALL.

VISITOR PROFILE

Primary business activity

Manufacturer	35.25%
Distributor	24.34%
Service provider	7.13%
Contract manufacturer (Bespoke product development)	6.5%
Retailer	5.15%
Private label provider	4.66%
Wholesaler	4.52%
Academic	2.33%
Equipment provider	1.04%
Press /Media	0.72%
Other	8.36%

Business sector (based on multiple responses)

Manufacturer (Dietary/Health supplements)	65.99%
Food	35.74%
Pharmaceuticals	33.75%
Health food	32.58%
Manufacturer (Functional food)	32.18%
Natural & herbal medicine	31.05%
Nutricosmetics	25.46%
Personal care	22.74%
Manufacturer (Functional beverages)	20.31%
Beverages	18.82%
Animal Health	14.52%

Main area of responsibility

Brand manager	18.07%
Business development	17.54%
Product development	15.58%
Sales	13.26%
Purchasing / procurement / buying	7.65%
Marketing	6.05%
Research / scientific / analytic	5.17%
Corporate management	3.78%
Advisors	3.66%
Operations	2.13%
Legal / regulatory / compliance	1.6%
Testing / quality assurance	0.83%
Education	0.74%
Finance	0.66%
Government	0.49%
Other	2.79%

Company size

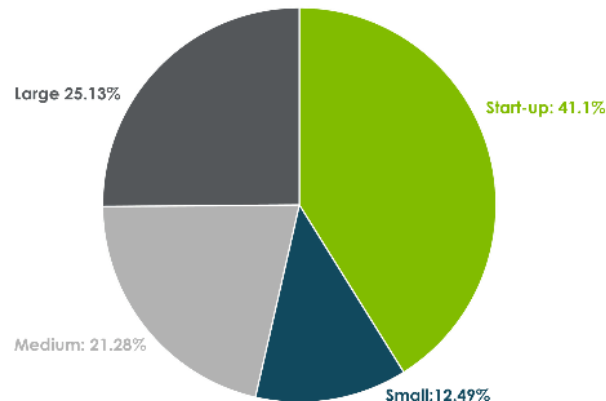

Probiotics
Top ingredient attendees were looking to source



Top 3 health categories of interest among visitors
Immune Health and Digestive & Gut Health

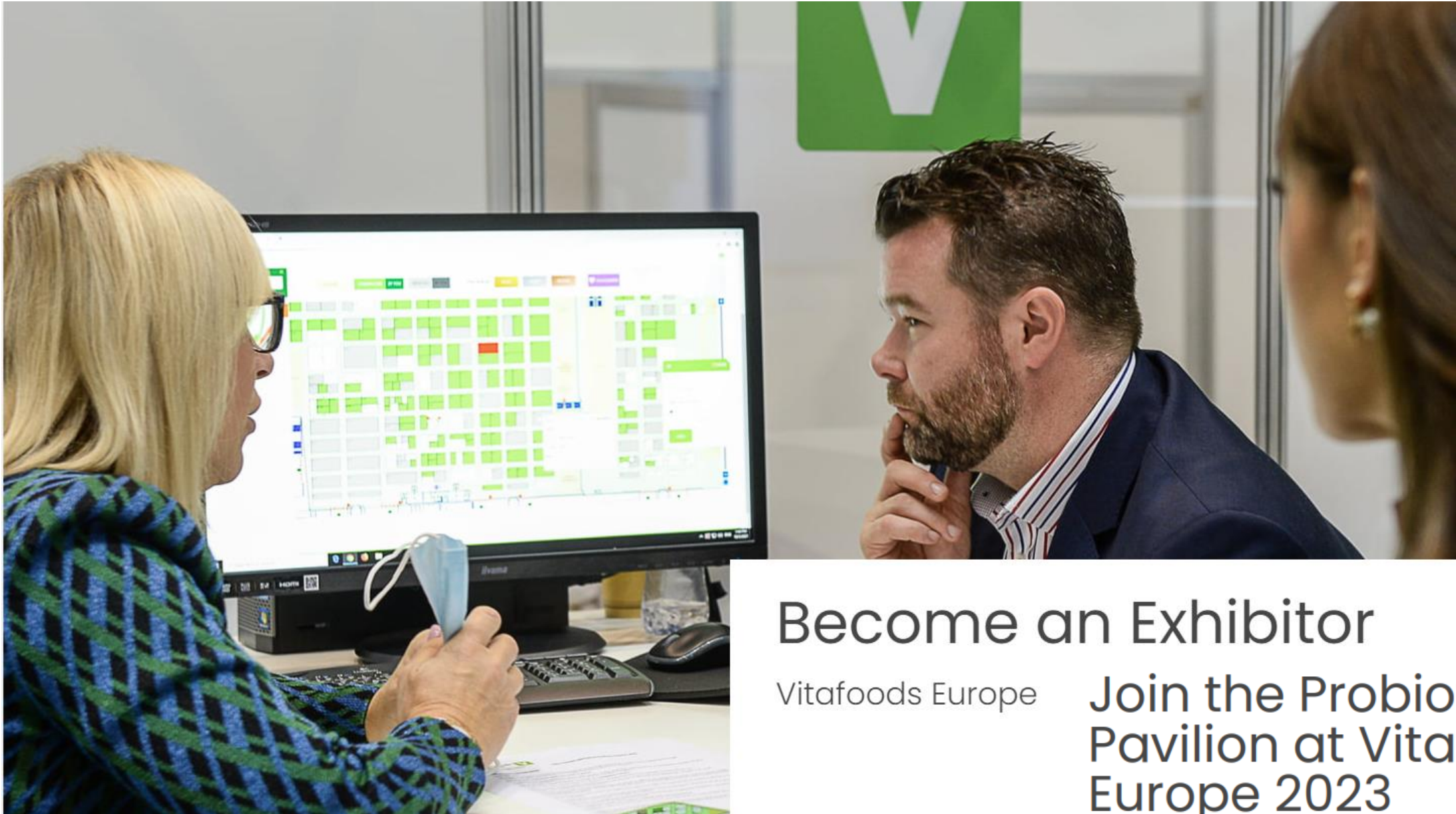

Become an Exhibitor

Vitafoods Europe

Join the Probiotics
Pavilion at Vitafoods
Europe 2023

THE PROBIOTICS RESOURCE CENTER VISUALS

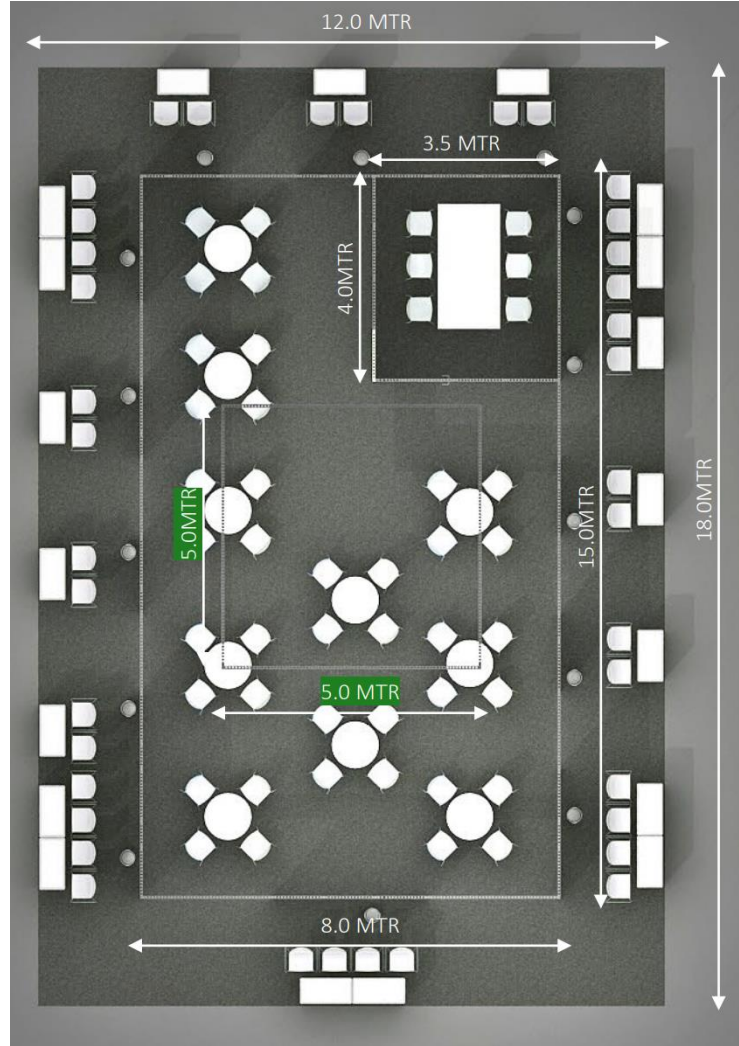

Align your company with this dominant attendee attraction at Vitafoods Europe 2023 and the International Probiotics Association by booking a stand in the Probiotics Resource Centre. Participating companies will benefit from a premium location at the front of the Probiotics Resource Centre, with prominent branding at your stand, all at a cost effective rate

POD INCLUSIONS

Scroll down for more details

STANDARD
€ 11,000

PREMIUM
€ 17,500

Counter and wall panel with graphics & 2 stools

Single

Double

Entry on the Exhibitor List

X

X

Company Logo in the Probiotics Guide

X

X

Access to the meeting area

X

X

Ingredients Network Fee

X

X

Registration Fee

X

X

Smart Connect Fee

X

X

Prominence at the front of the Probiotics Resource Centre

X

Probiotics Resource Centre

The Probiotics Resource Centre is developed in association with the International Probiotics Association (IPA) and enables attendees to understand everything there is to know about probiotics in one area, from the latest breakthroughs in probiotics technology, to new product development, consumer analysis and market trends.

Meet the most senior industry decision-makers looking to source Probiotics

THE PROBIOTICS RESOURCE CENTER IS BEING LOCATED IN H250

[>>FLOOR PLAN LINK<<](#)

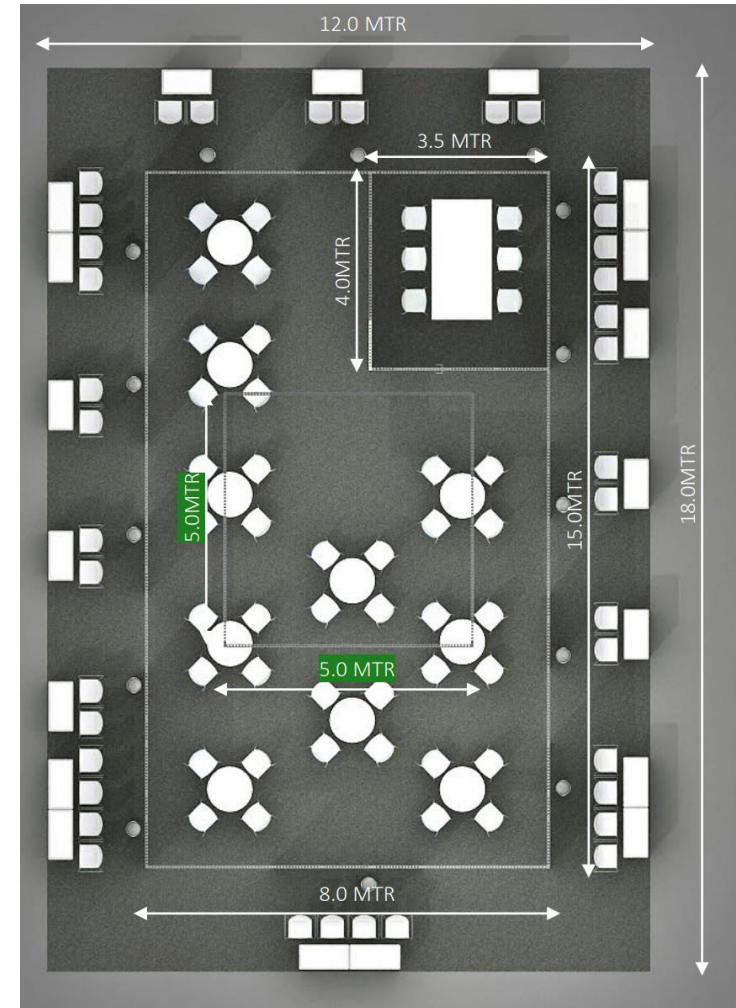
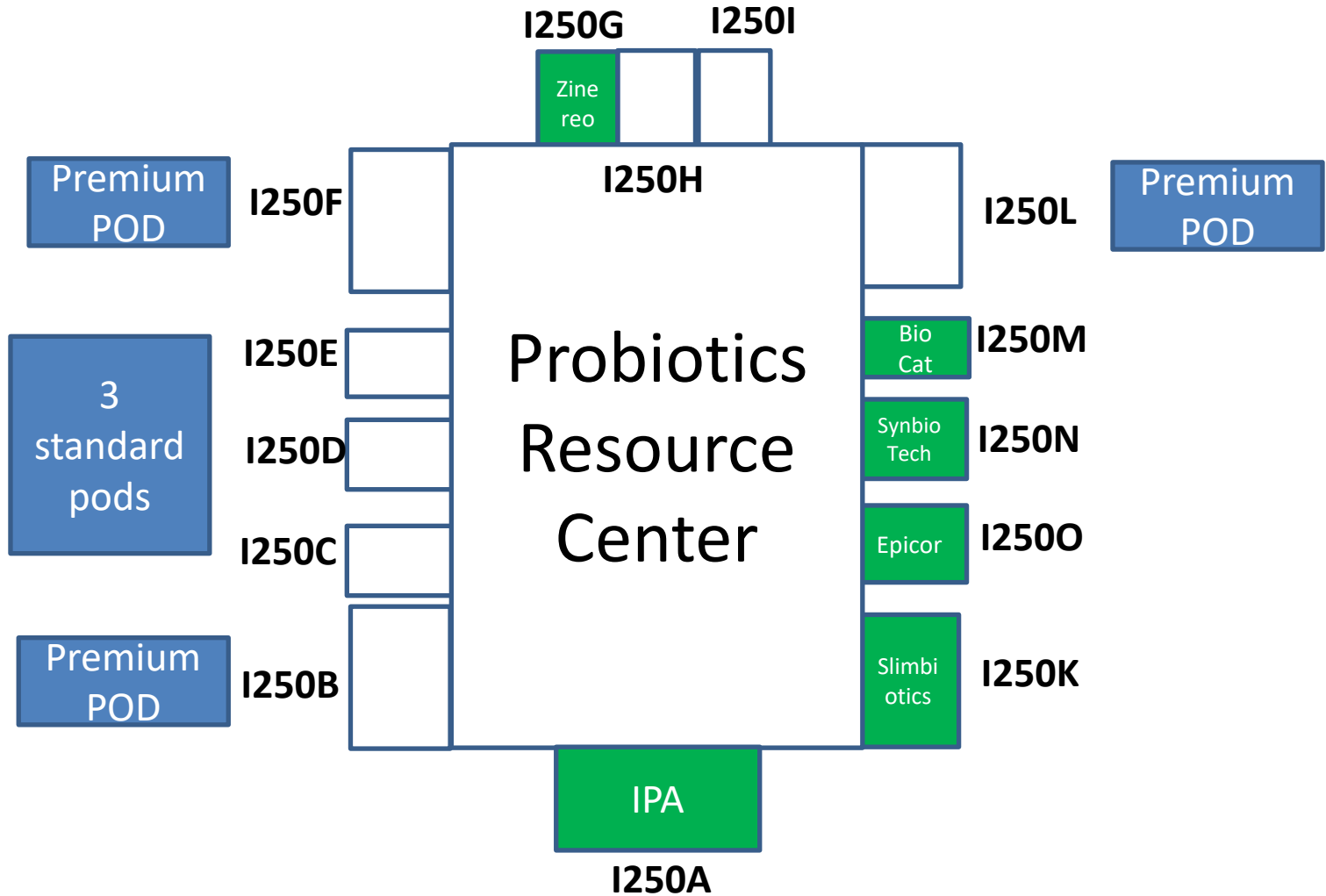

Probiotics Resource Centre Headline Sponsor: €27,500

Vitafoods Europe 2023 provides the perfect platform for businesses to be seen as industry leaders and to generate new business, while building profitable relationships across the global Probiotics industry. The Probiotics Resource Centre in association with IPA, provides a unique opportunity for your company to be aligned with the Probiotics market and stand out from your competition by becoming the Probiotics Resource Centre Headline Sponsor.



Headline package includes

BRAND AWARENESS

- Company logo and stand number highlighted as a Major sponsor in the Sponsors page of the Vitafoods Europe website.
 - Company highlight as the Headline Sponsor in the Probiotics Resource Centre page on the Vitafoods Europe website and event platform.
 - Up to 2 product showcases in the Probiotics Resource Centre.
 - Company highlight in the Probiotics guide – inclusive of:
 - Logo on the cover of the guide.
 - One full page ad.
 - Dedicated section for your products showcase and theatre sessions information.
 - Article feature.
- The guide is to be shared via e-mail to pre-registered audience and access free-of-charge on-site, on the event platform and website.
- Company logo in signage throughout the visitor journey: welcome banner, floorplan boards, and thank you to our sponsors banner.
 - Company logo included throughout the visitor attraction graphics alongside with IPA branding.

THOUGHT LEADERSHIP

- Two (2) theatre sessions of 25 minutes on each day of the Probiotics Theatre.
- Opportunity to pre-record your presentations and make available on-demand on the event platform.
- Q&A Article written in collaboration with a Vitafoods editor to be published on the Vitafoods Europe Online Content Hub . Content to be promoted via e-mail campaign, social media channel and Probiotics Guide.

MARKETING PROMOTION

- Company highlight as the Probiotics Resource Centre headline sponsor throughout the marketing campaign on selected e-mails and social media posts.

LEAD GENERATION

- Access to your sessions attendees list, both in person and online, with GDPR-compliant data post-event.

Probiotics Theatre Presentation

The Probiotics Theatre presents a unique opportunity to showcase your latest product offerings to a dedicated audience specifically looking to source Probiotics at Vitafoods Europe 2023.

These presentations will take place in the Probiotics Resource Centre, a dedicated knowledge hub at Vitafoods Europe that enables visitors to understand everything there is to know about Probiotics in one area.

This package includes:

- Company highlight as a Probiotics theatre sponsor on the Vitafoods Europe website and event platform.
- A 25min presentation in the Probiotics Theatre (in person, online, or both)
- Your presentation and speaker information on the Vitafoods Europe Agenda.
- Your presentation and speaker information in the Probiotics Guide to be shared via e-mail to pre-registered audience and made available to access free-of-charge on-site, on the event platform, and website.
- Access to your session attendees list with GDPR-compliant data post-event.
- Audience interaction – access to Live Chat box, share resources, post polls and answer questions. Available for online and hybrid mode only.

ONLINE only
€4,500

Pre-recorded presentation made available on-demand 1 week before in-person event dates. (produced by sponsor or with the Vitafoods team)

IN-PERSON only
€4,500

Presentation at theatre in Geneva, 9-10 May

HYBRID
€6,500

Pre-recorded presentation (produced by sponsor or with the Vitafoods team) PLUS presentation at theatre in Geneva, 9-10 May



Probiotics Theatre Presentation

IN-PERSON only
€4,500

HYBRID
€6,500



Remaining Schedule for Presentation at the Theater

	DAY 1 – Tuesday, 9th May		DAY 2 – Wednesday 10th May	
11:00 – 11:25	Slot 1		Slot 9	
11:30 – 11:55	Slot 2		Slot 10	
12:00 – 12:25	Slot 3		Slot 11	
12:30 – 12:55	Slot 4	AVAILABLE	Slot 12	
13:00 – 13:55	BREAK			
14:00 – 14:25	Slot 5		Slot 13	
14:30 – 14:55	Slot 6		Slot 14	
15:00 – 15:25	Slot 7	AVAILABLE	Slot 15	AVAILABLE
15:30 – 15:55	Slot 8	AVAILABLE	Slot 16	AVAILABLE

Probiotics Digital Guide

The Probiotics Guide is a must read annual reference tool and will be available to access free-of-charge on the Vitafoods Europe website and event platform from April to June 2023. Vitafoods visitors and audience beyond Geneva will be able to dive into the exhibitor list for the Probiotics resource centre, the latest insights from IPA, and discover new products focused on Probiotics and relate health categories.

The Probiotics Guide is promoted through e-mail and social media and be made available on-site through QR codes in the Probiotics Resource Centre, visitor entrance and media hub.

Pricing & Availability:

3,500 EUR

- **Plus:** First Page Ad + QA. Available for 1 company.

2,500 EUR

- **Basic:** Immersed Full Page. Available for 3 companies.

500 EUR

- **Company Listing:** Company description, logo and stand number.

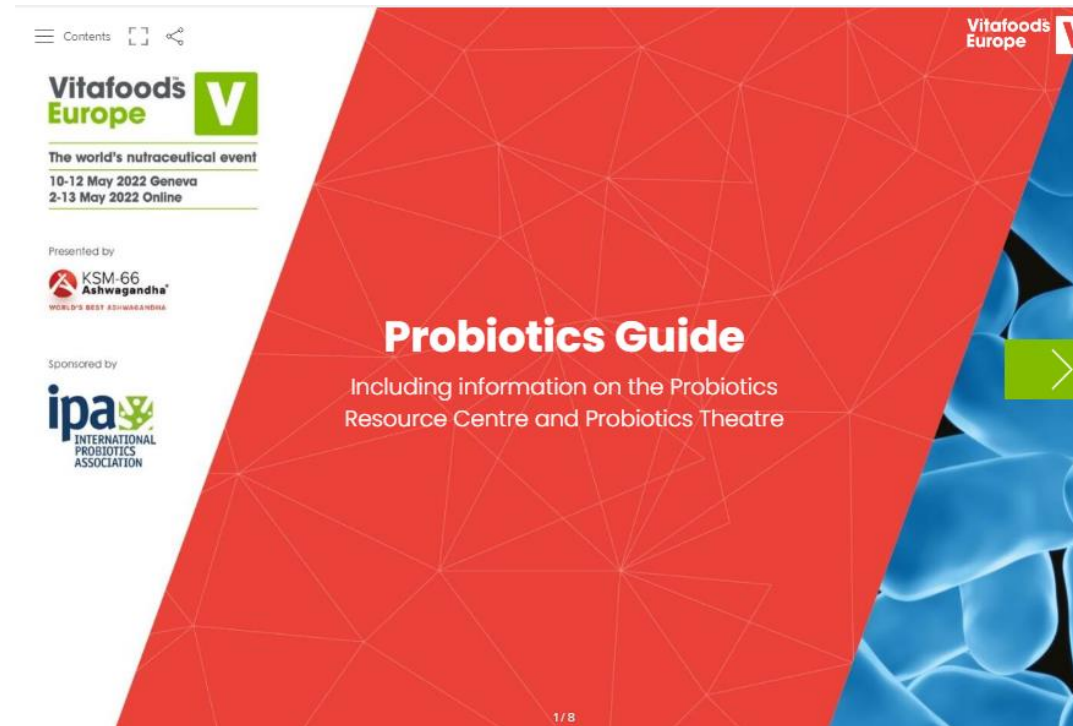

[>>Probiotics Guide 2022<<](#)

Probiotics Display : €2,750

The Probiotics Resource Centre is where visitors discover the latest breakthroughs in probiotic technology, new product development, consumer analysis and market trends. Showcasing your product in this must-attend area of the exhibition will guarantee a higher exposure to potential new clients.



Package includes:

- One (1) product display box, with informational card including: company name, logo, product name, description and stand number.
- Your product display within the Probiotics Resource Centre page in the event platform hyperlinked and increasing traffic to your company profile.
- Your product information, company logo and promotional asset* within the Probiotics Guide to be shared via e-mail to pre-registered audience and made available to access free-of-charge on-site and on the event platform and website.
***promotional asset can be an advert, a video or a pdf brochure.**

[>>Guidelines<<](#)

[>>Submission form<<](#)

Thank you for reading

**We hope to see
you soon!**

Vitafoods 2023



REFERENCES & CONTACT DETAILS

THE **INTERNATIONAL PROBIOTICS ASSOCIATION (IPA)** IS A GLOBAL NON-PROFIT ORGANIZATION BRINGING TOGETHER THROUGH ITS MEMBERSHIP, THE PROBIOTIC SECTOR'S STAKEHOLDERS INCLUDING BUT NOT LIMITED TO ACADEMIA, SCIENTISTS, HEALTH CARE PROFESSIONALS, CONSUMERS, INDUSTRY AND REGULATORS. THE IPA'S MISSION IS TO PROMOTE THE SAFE AND EFFICACIOUS USE OF PROBIOTICS THROUGHOUT THE WORLD. HOLDING NGO STATUS BEFORE *CODEX ALIMENTARIUS*, THE IPA IS ALSO RECOGNIZED AS THE UNIFIED **GLOBAL VOICE OF PROBIOTICS®** AROUND THE WORLD.

MERYL MASSOT

MEMBER SUPPORT COORDINATOR

(438) 926 2610

MERYL@INTERNATIONALPROBIOTICS.ORG